

DEPARTMENT OF THE ARMY TECHNICAL BULLETIN

**CALIBRATION PROCEDURE FOR
AUTOMATIC VIDEO CORRECTOR
TEKTRONIX, MODEL 1440
(NSN 5820-00-570-1978)**

Headquarters, Department of the Army, Washington, DC
24 March 1980

REPORTING OF ERRORS

You can help improve this publication by calling attention to errors and by recommending improvements and stating your reasons for the recommendations. Your letter or DA Form 2028 (Recommended Changes to Publications and Blank Forms) should be mailed directly to Commander, US Army Communications and Electronics Materiel Readiness Command, ATTN: DRSEL-ME-MQ, Fort Monmouth, NJ 07703.

A reply will be furnished direct to you.

	Paragraph	Page
SECTION I. IDENTIFICATION AND DESCRIPTION		
Test instrument identification	1	2
Calibration data card, DA Form 2416.....	2	2
Calibration description.....	3	2
II. EQUIPMENT REQUIREMENTS		
Equipment required	4	3
Accessories required.....	5	3
III. PRELIMINARY OPERATIONS		
Preliminary instructions	6	4
Equipment setup	7	4
IV. CALIBRATION PROCESS		
Timing circuits	8	6
Program compensation	9	8
Line-time non-linearity	10	10
Intermodulation and delay	11	10
Demodulator control	12	10
Power supply.....	13	12
Final procedure	14	13

**SECTION I.
IDENTIFICATION AND DESCRIPTION**

1. Test Instrument Identification. This bulletin provides instructions for the calibration of Automatic Video Corrector, Tektronix, Model 1440. The manufacturer's instruction manual was used as the prime data source in compiling these instructions. The automatic video corrector will be referred to as the "TI" (test instrument) throughout this bulletin.

a. Model Variations. None.

b. Time and Technique. The time required for this calibration is approximately 4 hours, using the dc and low frequency technique.

2. Calibration Data Card, DA Form 2416. a. Forms, records, and reports required for calibration personnel at all levels are prescribed by TM 38-750. DA Form 2416 must be annotated in accordance with TM 38-750 for each calibration performed.

b. Adjustments to be reported on DA Form 2416 are designated (R) at the end of the sentence in which they appear. Report only those adjustments made and designated with (R).

3. Calibration Description. Test instrument parameters and performance specifications which pertain to this calibration are listed in table 1.

Table 1. Calibration Description

Test Instrument Parameters	Performance Specifications
Timing	Verifies proper timing of oscillator, sync, and gating circuits.
Program compensation	Verifies proper function of gain control circuits in both "auto" and "preset" modes.
Line time non-linear distortion	0.5% verified with differentiated unmodulated staircase.
Pedestal intermodulation	0.5 IRE units (3.6 mv) or less.
Chrominance and luminance delay	10 ns or less.
Signal delay	Introduces less than 5 degrees phase shift of burst signal.
Demodulator control reference signal ratio.	Verifies proper control of VIR signal to O-carrier

**SECTION II.
EQUIPMENT REQUIREMENTS**

4. Equipment Required. Table 2 identifies the specific equipment used in this calibration procedure. This equipment is issued with secondary transfer standards calibration sets NSN 6695-00621-7877, AN/GSM-256, and AN/GSM-259, and is to be used in performing this procedure. Additional equipment is required to calibrate this TI as indicated in table 2. This equipment is located at the site of the TI. To prevent unnecessary delay, have your local calibration coordinator schedule the TI and related equipment for calibration within the same time frame. Alternate items may be used by the calibrating activity when the equipment listed in table 2 is not available. The

items selected must be verified to perform satisfactorily prior to use and must bear evidence of current calibration. The equipment must meet or exceed the minimum use specifications listed in table 2. The accuracies listed in table 2 provide a four-to-one accuracy ratio between the standard and test instrument.

5. Accessories Required. The accessories listed in table 3 are issued as indicated in paragraph 4 above and are to be used in this calibration procedure. When necessary, these items may be substituted by equivalent items unless specifically prohibited.

Table 2. Minimum Specifications of Equipment Required

Item	Common Name	Minimum Use Specifications	Manufacturer, Model, and Part Number	
			Secondary transfer	AN/GSM-256 or AN/GSM-259
A1	VARIABLE TRANSFORMER	Range: 105 to 125 vac Accuracy: +-1%	General Radio, Model W10OMT3AS3 (7910809)	General Radio, Model W10OMT3AS3(7910809).
A2	BLACK BURST SOURCE	Output: Signal consisting of composite sync and burst.	Tektronix, Type 146. ¹	Tektronix, Type 146.1
A3	DC VOLTMETER	Range: +15 vdc Accuracy: +0.25 %	Dana, Model 5703-S-2127 (7912606)	Hewlett-Packard, Model 3490A w/Option 060 (6625-00-557-8305).
A4	OSCILLOSCOPE	Deflection: 1 mv/div Bandwidth: DC to 30 MHz Accuracy: +3%	Tektronix, Type RM561A MOD 171 (7910655-4) w/ Type 3A6 (7911441-2) and Type 3B4 (7912040-1)	Hewlett-Packard, Model 180D (6625-00-022-8228) w/1805A plug-in (6625-00-777-3083) and 1825 plug-in (662500-022-8422).
A5	VECTORSCOPE		Tektronix, Type 520A. ¹	Tektronix, Type 520A. ¹
A6	VIDEO SIGNAL SOURCE		Tektronix, Type 149.1 ¹	Tektronix, Type 149. ¹
A7	WAVEFORM MONITOR		Tektronix, Type R529. ¹	Tektronix, Type R529. ¹
¹ Additional equipment required Available with test instrument. See remote plug modification in paragraph 6.				

Table 3 Accessories Required

Item	Common Name	Description and Part Number	
		Secondary transfer	AN/GSM-256 and AN/GSM-259
B1	CABLE (9 required)	Cable assembly, radio frequency BNC termination, normal length	Same.
B2	PROBE	X10 attenuating probe, Tektronix, Type P6006 (7911454)	Supplied with 180D oscilloscope.
B3	TERMINATION	75-ohm BNC plug	Same.
B4	Connector	BNC "T" connector	Same.

SECTION III. PRELIMINARY OPERATIONS

6. Preliminary Instructions. a. The instructions outlined in this section are preparatory to the calibration process. Personnel should become familiar with the entire bulletin before beginning calibration.

SAFETY PRECAUTION

A periodic review of safety precautions in TB 385-4 is recommended. When the equipment is operated with covers removed, DO NOT TOUCH exposed connections or components. MAKE CERTAIN you are not grounded when making connections or adjusting components inside the test instrument.

WARNING

HIGH VOLTAGE is used during the performance of this calibration. DEATH ON CONTACT may result if personnel fail to observe safety precautions.

WARNING

DO NOT ATTEMPT to make internal connections or adjustments unless another person, capable of performing

first aid, is present.

WARNING

The protective grounding terminals of the test instrument and the calibration equipment must be connected to the equipment grounding (safety) conductor of the power cords. For electric shock protection use only extension cords and power recepticals with a safety-ground connector, or otherwise connect the chassis to a safety ground system.

b. Items of equipment used in this procedure are referenced within the text by common name and item identification number as listed in tables 2 and 3. For identification of equipment referenced by item numbers prefixed with A, see table 2, and for prefix B, see table 3.

c. The remote plug P9014 on video signal source (A6) must be modified to allow sync and phase lock of the Fuel Field signal while using a black burst synchronizing signal. Figure 1 shows wiring details to provide this function.

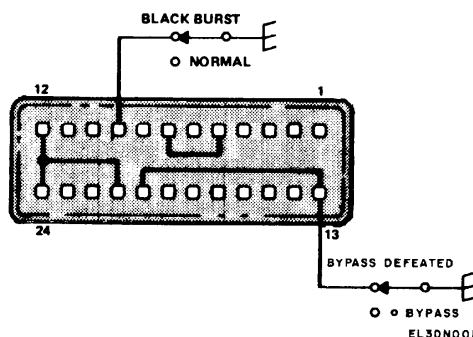

Figure 1. Video signal source remote plug wired for Automatic Video Corrector calibration

NOTE

Unless otherwise specified, all control and control settings refer to the test instrument.

7. Equipment Setup. a. Connect T1 to variable transformer (A1).

b. Connect variable transformer to 115-volt ac source and adjust the output to 115 volts.

c. Set TI switch to ON and allow 15 minutes for warmup and stabilization.

d. Connect equipment as shown in figure 2.

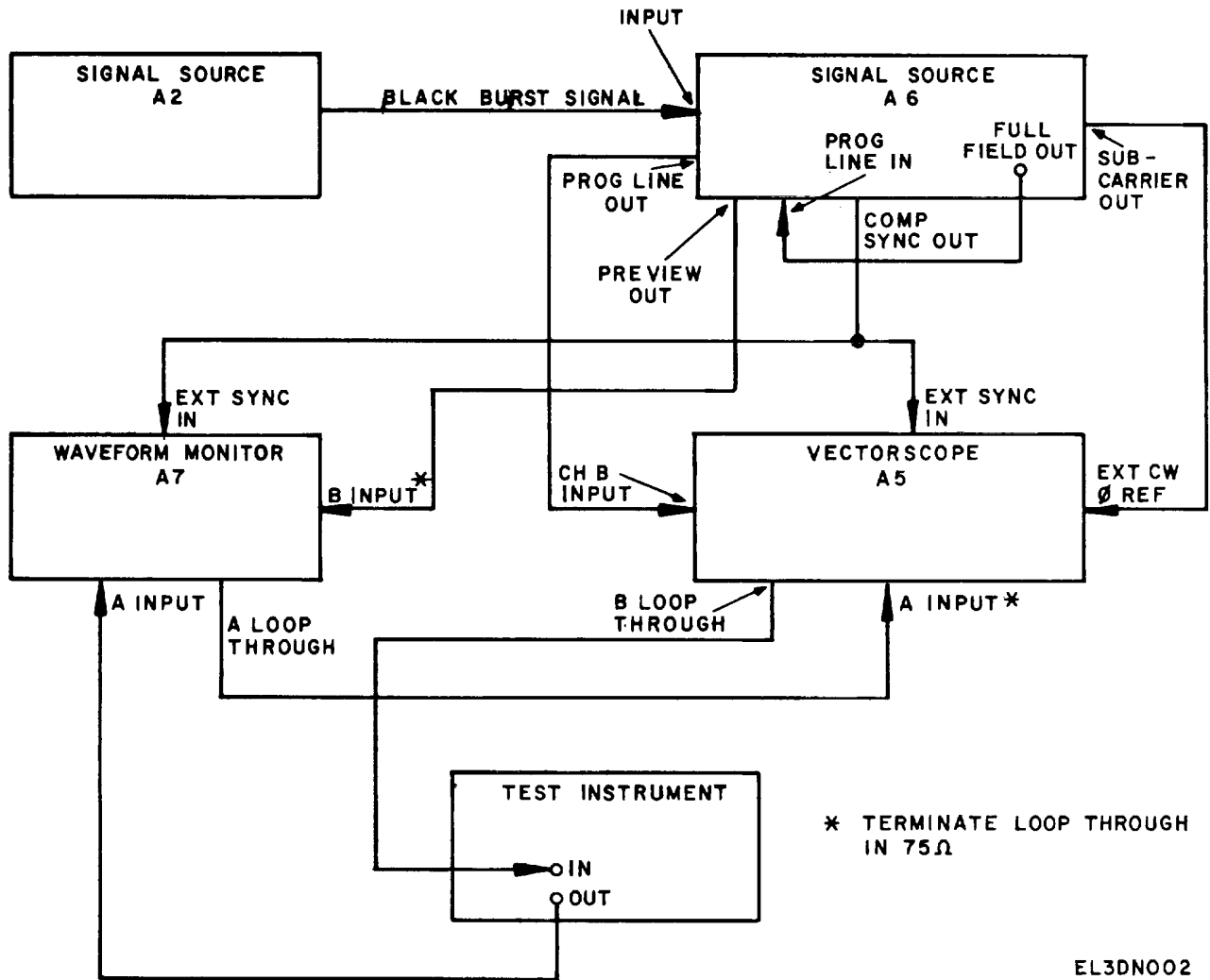

EL3DN002

Figure 2. Preliminary equipment setup.

SECTION IV. CALIBRATION PROCESS

NOTE

Unless otherwise specified, verify the results of each test and, whenever the test requirement is not met, take corrective action before continuing with the calibration.

8. Timing Circuits. a. Performance Check.

(1) Connect the oscilloscope (A4) to TI TP3308 (fig. 3), using probe (B2).

(2) If dc level indicated on oscilloscope exceeds +20 millivolts, perform b(1) below.

(3) Connect oscilloscope probe to TP3250 (fig. 3).

If width of displayed pulse is not 4 ± 0.2 microseconds, perform b(2) below.

(4) Turn TI PEDESTAL DELAY and START controls to midrange.

(5) Connect oscilloscope probe to TP3385 (fig. 3). If width of displayed pulse is not 11 ± 1 microseconds, perform b(3) below.

(6) Connect oscilloscope probe to P3912-3 (fig. 3) (7) Adjust oscilloscope to display horizontal sync pulse and position leading edge of pulse at second vertical graticule line.

(8) Connect oscilloscope probe to TP3876 (fig. 3). If trailing edge of displayed pulse is not 8.5 ± 0.5 microseconds from second vertical graticule line, perform b(4) below.

(9) Repeat (6) and (7) above.

(10) Connect oscilloscope probe to TP4141 (fig. 3). If leading edge of displayed pulse is not 17 ± 0.5 microseconds from second vertical graticule, perform b(5) below; if trailing edge is not 32 ± 0.5 microseconds from second vertical graticule, perform b(6) below.

(11) Connect oscilloscope probe to TP4139 (fig. 3). If trailing edge of displayed pulse is not 46 ± 1 microseconds from second vertical graticule line, perform b(7) below.

(12) Connect oscilloscope probe to TP4505 (fig. 3).

(13) Adjust oscilloscope to display VIR (vertical interval reference) signal. Adjust L4378 (fig. 3) for

minimum chroma (signal level) on 0.5-volt pedestal of waveform.

(14) Connect oscilloscope probe to TP4539 (fig. 3). Adjust L4460 and L4456 (fig. 3) for optimum peak response of the demodulated VIR signal and chroma.

(15) Adjust video signal source (A6) for 10 percent APL (average picture level) flat field output. If APL, as indicated on oscilloscope is not zero, perform b(8) below.

(16) Adjust TI PEDESTAL DELAY control for minimum aberration on waveform approximately 62 microseconds from leading edge of horizontal sync pulse.

(17) Adjust TI PEDESTAL START control for minimum aberration on waveform approximately 11 microseconds from leading edge of horizontal sync pulse.

(18) Adjust video signal source for 0 APL flat field output. If APL, as indicated on oscilloscope, is not zero, perform b(8) below.

b. Adjustments (1) Adjust L3400 (fig. 3) for oscilloscope indication of zero volt dc (R).

(2) Adjust R3624 (fig. 3) for 4-microsecond pulse width (R).

(3) Adjust R3156 (fig. 3) for 11-microsecond pulse width (R).

(4) Adjust R3282 (fig. 3) until trailing edge of displayed pulse is 8 microseconds from second vertical graticule line (R).

(5) Adjust R3534 (fig. 3) until leading edge of displayed pulse is 17 microseconds from second vertical graticule line (R).

(6) Adjust R3438 (fig. 3) until trailing edge of displayed pulse is 32 microseconds from second vertical graticule line (R).

(7) Adjust R3540 (fig. 3) until trailing edge of displayed pulse is 46 microseconds from second vertical graticule line (R).

(8) Adjust R5404 (fig. 4) for zero APL indication on oscilloscope (R).

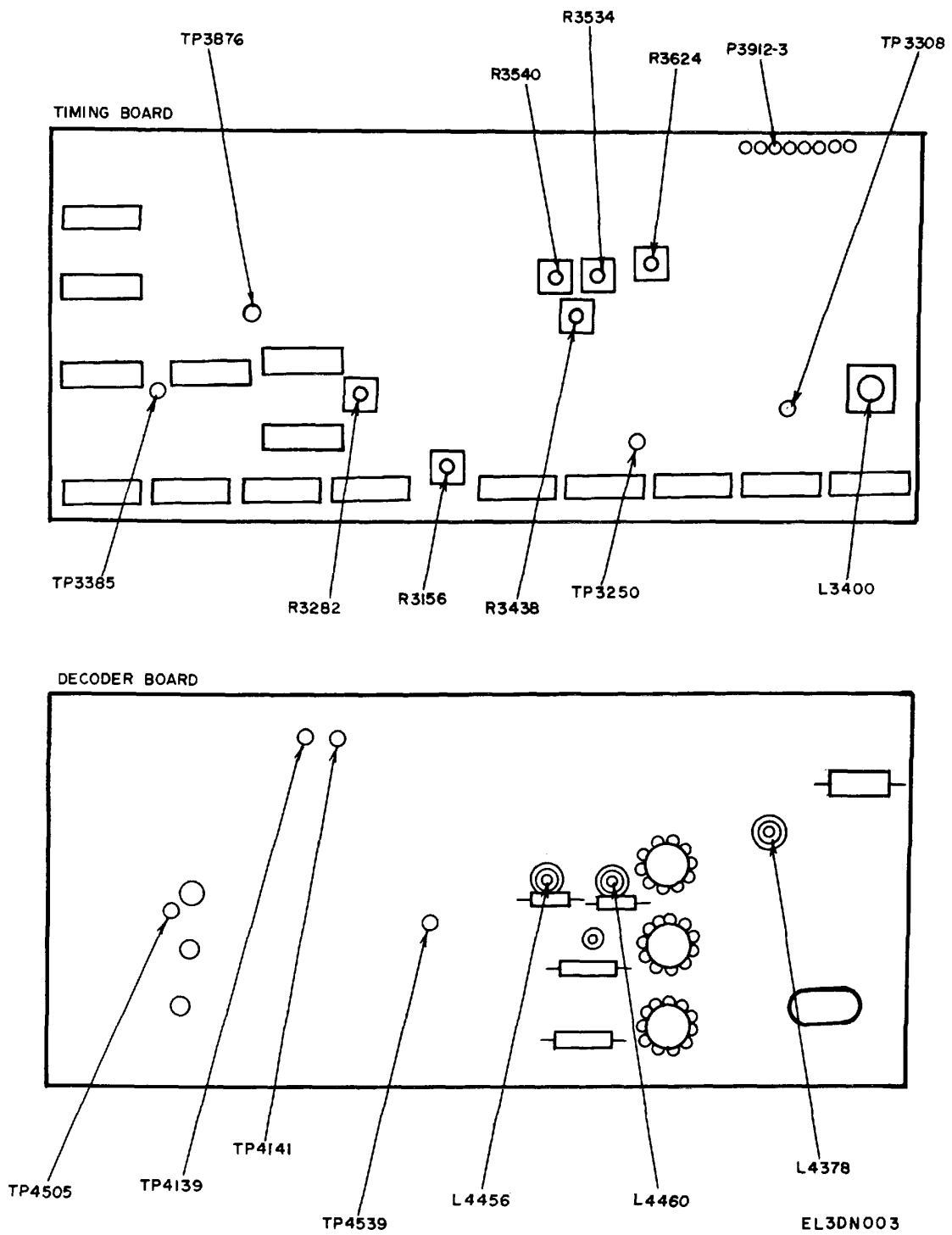

Figure 3. Timing and decoder boards - component locations.

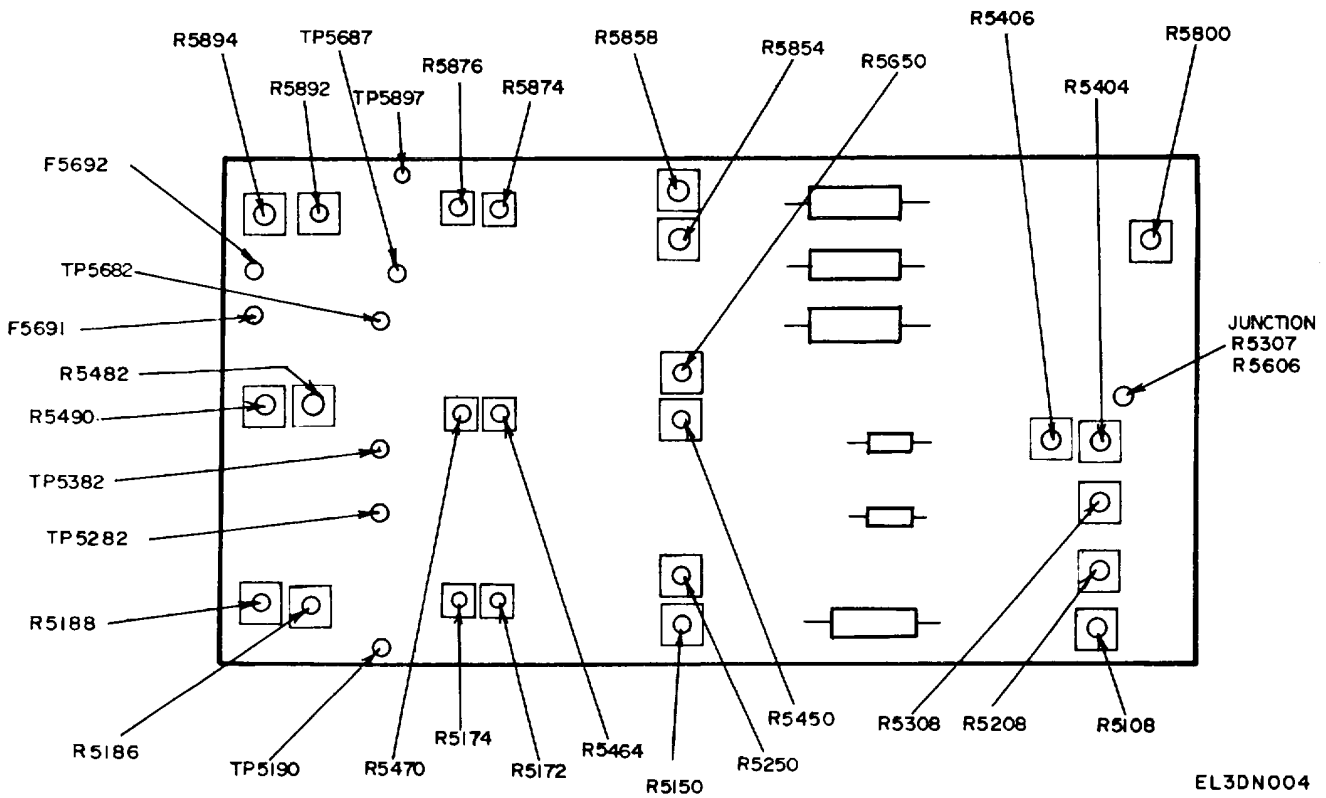

Figure 4. Error amplifier board - component locations.

9. Program Compensation. a. Performance Check
- (1) Adjust waveform monitor (A7) for A-B differential measurement.
 - (2) Set manual luminance gain for unity gain through T1.
 - (3) Adjust manual chroma gain R5854 (fig. 4) for minimum preshoot on T pulse in sin2 pulse and bar signal.

(4) Verify that 4.1 MHz multiburst packet is of equal amplitude to white bar. If not, perform b(l) below.

(5) Adjust C2790 and R2990 (fig. 5) for best response of T pulse in sin2 pulse and bar signal.

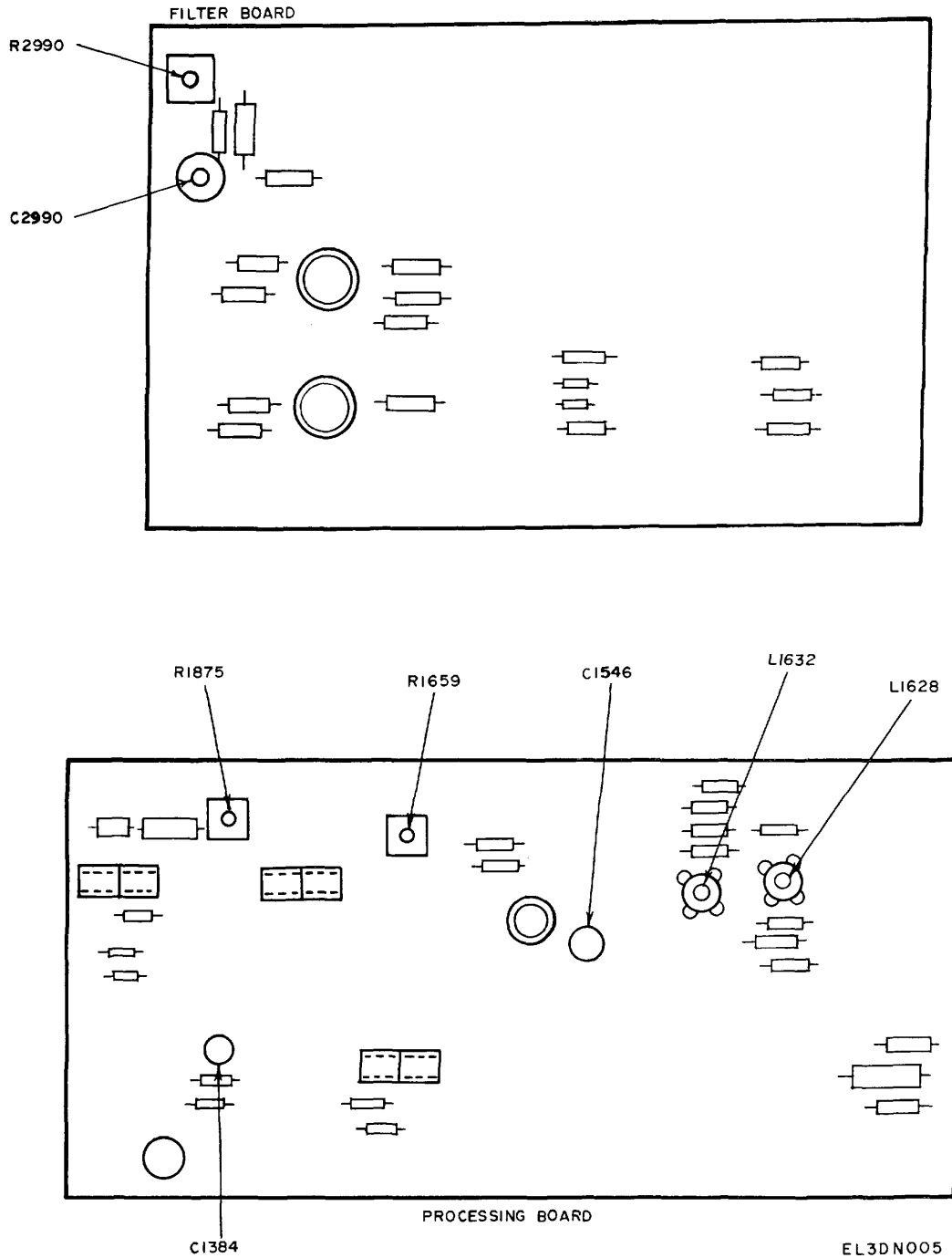

Figure 5. Filter and processing boards - component locations.

(6) Repeat (2) through (5) above to compensate for interaction of control settings.

(7) Connect output of video signal source (A6) directly to CH-A input of vectorscope (A5).

(8) Adjust vectorscope CH-A gain until displayed burst tip is exactly on graticule edge.

(9) Connect video signal source output to TI PROGRAM IN, and connect TI PROGRAM OUT to vectorscope CH-A input.

(10) While rotating R5250 (fig. 4) to display both sides of VIR signal, verify that burst amplitude on both sides is equal. If amplitudes are unequal, perform b(2) below.

(11) Adjust R5250 to overlay burst and VIR signal vectors.

(12) Remove fuses F5692 and F5691 (fig. 4).

(13) Set waveform monitor for differential measurement.

(14) Adjust R5406 and R5404 (fig. 4) for null on waveform monitor.

(15) Set waveform monitor for single channel operation, and adjust R5800 (fig. 4) for flat bottom on 12.5 T pulse.

(16) Set waveform monitor for differential measurement, and adjust R5308 (fig. 4) for null indication.

(17) Adjust R5208 (fig. 4) to overlay burst and VIR signal amplitude as displayed on vectorscope.

(18) Adjust R5108 (fig. 4) to overlay burst and VIR signal phase as displayed on vectorscope.

(19) Set waveform monitor for differential measurement.

(20) Adjust R5858 and R5450 (fig. 4) for null indication on waveform monitor.

(21) Repeat (15) above, but adjust R5854 (fig. 4).

(22) Repeat (16) above, but adjust R5650 (fig. 4).

(23) Repeat (17) and (18) above, adjusting R5150 and R5250 (fig. 4), respectively.

(24) Replace fuses F5692 and F5691 removed in (12) above.

(25) Connect oscilloscope (A4) to test points listed in (a) through (f) below, using probe (B2).

Refer to figure 4 for test point locations. If oscilloscope does not indicate zero volt dc at each test point, perform b(3) below.

(a) TP5382.

(b) TP5897.

(c) TP5682.

(d) TP5687.

(3) TP5282.

(f) TP5190.

b. Adjustments

(1) Adjust C1384 (fig. 5) until 4.1 MHz multiburst packet and white bar are of equal amplitude (R).

(2) Adjust L1632 and L1628 (fig. 5) for equal amplitude of burst on both sides of VIR signal phase.

(3) Perform corresponding adjustments for zero volt at each test point listed below (see fig. 4).

(a) TP5382 R5464 (R).

(b) TP5897 R5876 (R).

(c) TP5682 R5470 (R).

(d) TP5687 R5874 (R).

(e) TP5282 R5174 (R).

(f) TP5190 R5172 (R).

10. Line-Time Non-Linearity. a. Performance Check

(1) Adjust video signal source (A6) for unmodulated, 5-step staircase output.

(2) Adjust A input of waveform monitor (A7) for 1 volt full scale.

(3) Difference in riser amplitude between any two steps will be 3.6 millivolts or less.

b. Adjustments. No adjustments can be made.

11. Intermodulation and Delay. a. Performance Check

(1) Adjust video signal source (A6) for modulated pedestal output.

(2) Set response switch of waveform monitor (A7) to LOW PASS.

(3) Change in pedestal level caused by intermodulation will not exceed 3.7 millivolts.

(4) Adjust video signal source output for modulated 12.5 T pulse.

(5) Verify that chrominance to luminance delay at baseline of 12.5 T modulated pulse is 5 nanoseconds or less. Any sine wave shape of the chrominance at baseline will be 7 millivolts peak to-peak or less.

(6) Adjust PHASE control of vectorscope (A5) to set burst vector at 180° graticule line.

(7) Set TI to bypass mode. Burst vector will not shift more than 5° from 180° graticule line.

b. Adjustments. No adjustments can be made.

12. Demodulator Control. a. Performance Check

(1) Connect jumper P669 on 0-carrier reference board (fig. 6) so that R679 is connected to P679-5.

O-CARRIER REFERENCE BOARD

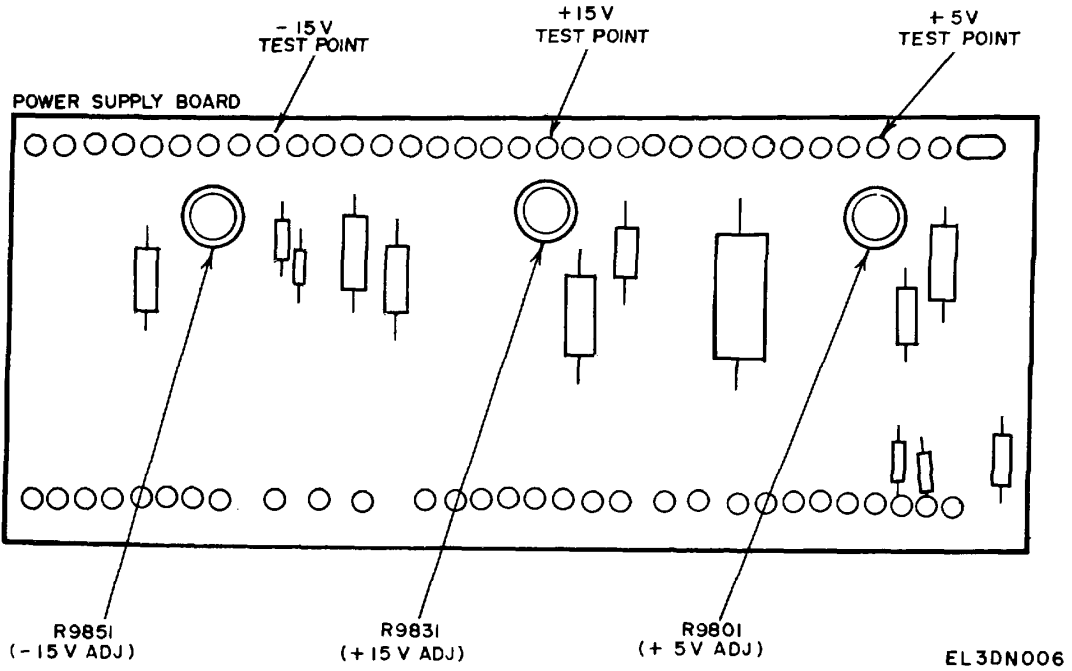
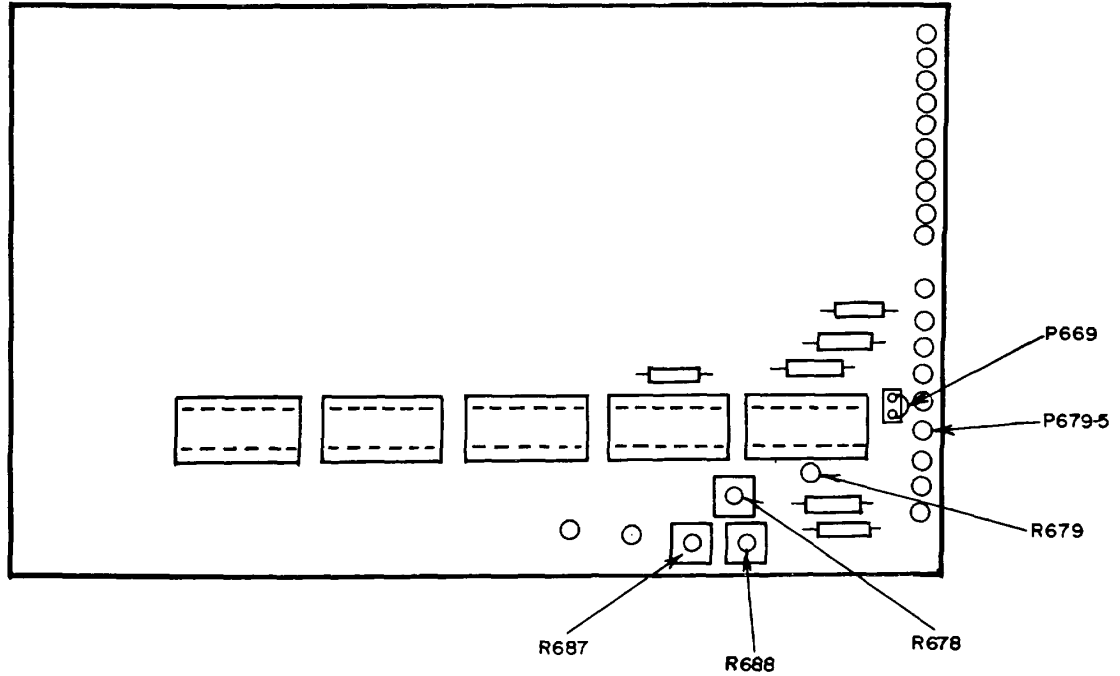

Figure 6. Zero-carrier reference and power supply boards
-component locations.

(2) Connect equipment as shown in figure 7.

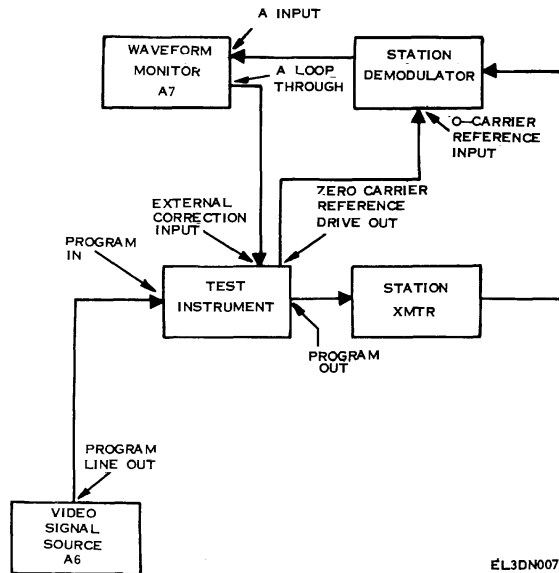

Figure 7. Demodulator control - equipment setup.

(3) Set HORIZONTAL DISPLAY control on waveform monitor (A7) to 2 FIELD and MAGNIFIER to X25.

(4) Adjust waveform monitor controls to display 0-carrier reference pulse. If start of 0-carrier reference pulse is not 12 +1 microseconds from leading edge of horizontal sync pulse, perform b(1) below.

(5) Adjust gain of station demodulator (fig. 7) for 0-carrier reference pulse amplitude of 120 IRE (857 millivolts).

(6) Connect oscilloscope (A4) to P679-5 (fig. 6), using probe (B2).

(7) If oscilloscope does not indicate approximately 0 volt, perform b(2) below.

(8) Adjust demodulator gain for 0-carrier reference pulse amplitude of 100 IRE (7.14 millivolts). Verify that VIR signal 50 IRE level to 0-carrier reference pulse ratio is correct.

(9) Connect oscilloscope probe to junction of R5307 and R5606 (fig. 4). If oscilloscope does not indicate approximately 0 volt, perform b(3) below.

b. Adjustments

(1) Adjust R678 (fig. 6) until start of 0-carrier reference pulse is 12 microseconds from leading edge of horizontal sync pulse.

(2) Adjust R687 (fig. 6) for 0 volt dc indication on oscilloscope.

(3) Adjust R688 (fig. 6) for 0-volt dc indication on oscilloscope.

13. Power Supply.

NOTE

Do not perform power supply checks if all other parameters are within tolerance.

a. Performance Check

(1) Connect dc voltmeter (A3) to -15 volt test point (fig. 6) and chassis ground. If dc voltmeter does not indicate between -14.85 and -15.15 volts, perform b(1) below.

(2) Adjust output of autotransformer (A1) from 105 to 125 volts ac then back to 115 volts. DC voltmeter indication will remain between -14.85 and -15.15 volts.

(3) Connect dc voltmeter between +5 volt test point (fig. 6) and chassis ground. If dc voltmeter does not indicate between 4.95 and 5.05 volts, perform b(2) below.

(4) Repeat technique of (2) above; dc voltmeter indication will remain between 4.95 and 5.05 volts.

(5) Connect dc voltmeter between + 15 volt test point (fig. 6) and chassis ground. If dc voltmeter does not indicate between 14.85 and 15.15 volts, perform b(3) below.

(6) Repeat technique of (2) above; dc voltmeter indication will remain between 14.85 and 15.15 volts.

b. Adjustments

(1) Adjust R9851 (fig. 6) for -15.00 volt

indication on dc voltmeter.

(2) Adjust R9801 (fig. 6) for 5.00 volt indication on dc voltmeter.

(3) Adjust R9831 (fig. 6) for 15.00 volt indication on dc voltmeter.

14. Final Procedure. a. Deenergize and disconnect all equipment and replace TI protective cover.

b. In accordance with TM 38-750, annotate and affix DA Label 80 (US Army Calibrated Instrument). When the TI receives limited or special calibration, annotate and affix DA Label 163 (US Army Limited or Special Calibration). When the TI cannot be adjusted within tolerance, annotate and affix DA Form 2417 (US Army Calibration System Rejected Instrument).

By Order of the Secretary of the Army:

Official:

J.C.PENNINGTON
Major General, United States Army
The Adjutant General

E. C. MEYER
General, United States Army
Chief of Staff

Distribution:

To be distributed in accordance with DA Form 12-34A, Requirements for Calibration Procedures Publications.

U.S. GOVERNMENT PRINTING OFFICE: 19B-6651191208

PIN: 044943